

ALPRO

Weekend-System II

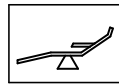

I. Operating instructions

II. Installation instructions

820011GB-02

Rev. 3 – 04/2015

LIST OF CONTENTS

I. Operating instructions

Paragraph.....	Page
1 Directions for use.....	4
2 Operating conditions of the Weekend-System.....	5
3 Operation.....	6
3.1 Switching the Weekend-System on and off.....	6
3.2 Filling the tank.....	6
3.3 Chronological procedure of application.....	7
4 Maintenance.....	9
5 Troubleshooting.....	9

II. Installation instructions

Paragraph.....	Page
1 Initial thorough cleaning of the water pipes.....	10
2 Position with respect to the treatment unit.....	11
2.1 Delivery contents.....	11
2.2 Position with respect to the treatment unit.....	11
2.3 Connection to the treatment unit.....	11
2.4 Connection diagram.....	12
2.5 Instructions for installation.....	13
3 Specifications.....	14
3.1 Technical values.....	14
3.2 Diagram of the device.....	15
3.3 Spare parts.....	16
3.4 Circuit diagram.....	16

ZERTIFIKAT CERTIFICATE CERTIFICADO CERTIFICAT ZERTIFIKAT CERTIFICADO CERTIFICATE CERTIFICADO CERTIFICAT



**KONFORMITÄTSERKLÄRUNG
DECLARATION OF CONFORMITY**

für das Medizinprodukt Klasse I

for the medical device class I

Weekend-System II

Beistellgerät zum Anschluss an zahnärztliche Behandlungseinheiten. Über das Wochenende wird mit dem Gerät „Weekend-System II“ das Medizinprodukt und Entkeimungsmittel Bilpron in die wasserführenden Leitungen der Behandlungseinheit gebracht und sorgt somit für deren Entkeimung

Chair-side device for connection to dental treatment units. By means of the device "Weekend-System II" the medical device and decontamination agent Bilpron is injected into the waterlines of the treatment unit over the weekend and thus ensures their decontamination

durch

by

**ALPRO MEDICAL GMBH
Mooswiesenstr. 9
D - 78112 St. Georgen**

auch Hersteller dieses Medizinprodukts ist und erklärt dass dieses Medizinprodukt den Grundlegenden Anforderungen der Richtlinie 93/42/EWG entspricht und eine vollständige Dokumentation vorliegt. Das Konformitätsbewertungsverfahren wurde gemäß Anhang VII der Richtlinie 93/42/EWG durchgeführt.

also manufacturer of this medical device and declares that this medical device corresponds to the basic requirements of the Directive 93/42/EEC and that a complete documentation is available. The evaluation of conformity was carried out according to Appendix VII of the Directive 93/42/EEC.



Qualitätsbeauftragter/ quality manager

Das Qualitätssicherungssystem der
ALPRO MEDICAL GMBH
ist zertifiziert nach
DIN EN ISO 13485:2012

The Quality Management System of
ALPRO MEDICAL GMBH
is certified in accordance with
DIN EN ISO 13485:2012

I. Operating instructions

These operating instructions must always be available near the device. They have to be read and used by each person who is instructed to the works at the device (Installation, operation and maintenance).



Danger!

This ***danger*** symbol describes safety instructions which can lead to endangerings of persons in case of non-observance.

Apart from the information in these operating instructions you have to bear in mind the generally applicable safety and accident prevention regulations!



Attention!

This ***attention*** symbol identifies any security advice of which the disregard might lead to dangers for the device and its function!



Information

This ***information*** symbol identifies particularities of which the observance is necessary for the perfect function of the device!

1 Directions for use

The Weekend-System must only be used for the injection of BILPRON into the water pipes of dental treatment units.

The device is designed to be operated by skilled and qualified personnel and not by the patient.

The Weekend-System must only be used within the pressure areas indicated (see paragraph "Specifications").



Danger!

BILPRON must only be used in suitable devices (not in the ALPRON-TEC!) and has to be rinsed out of the lines after the intended time of effect!

2 Operating conditions of the Weekend-System

1 Non-operation (during the week)

Weekend-System is switched off:

- Water flows through without any hindrance.
- Tank is not under pressure as the pressure valve closes the way of the air.

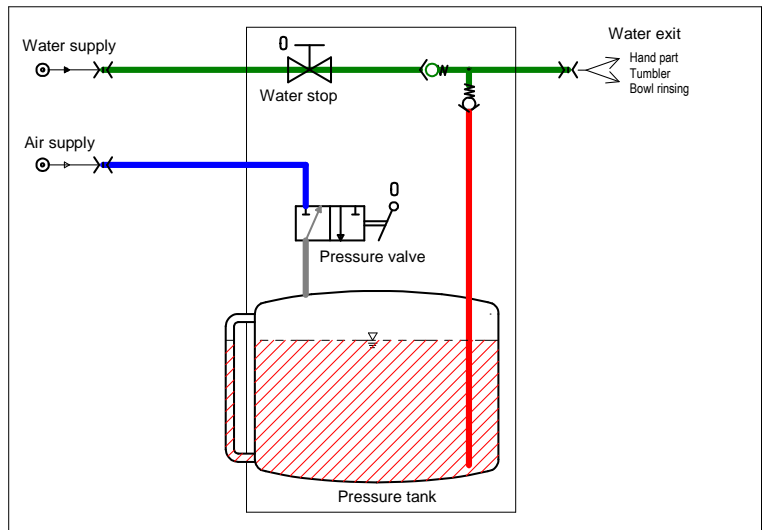

2 Injection of BILPRON (on Fridays)

Weekend-System is switched on:

- Water is stopped.
- Tank is put under pressure.
- BILPRON is injected.

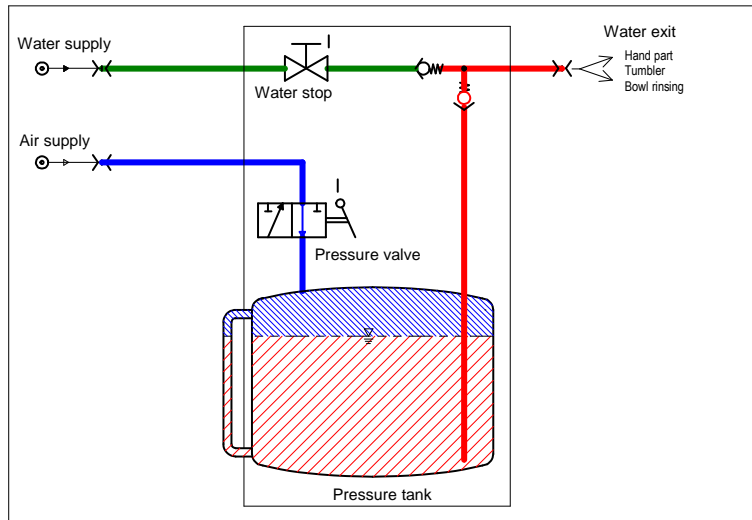

3 Reaction time (over the weekend)

Weekend-System is switched off again:

- Water remains in a stopped position.
- BILPRON still remains in the lines and has to be rinsed out after the time of effect.

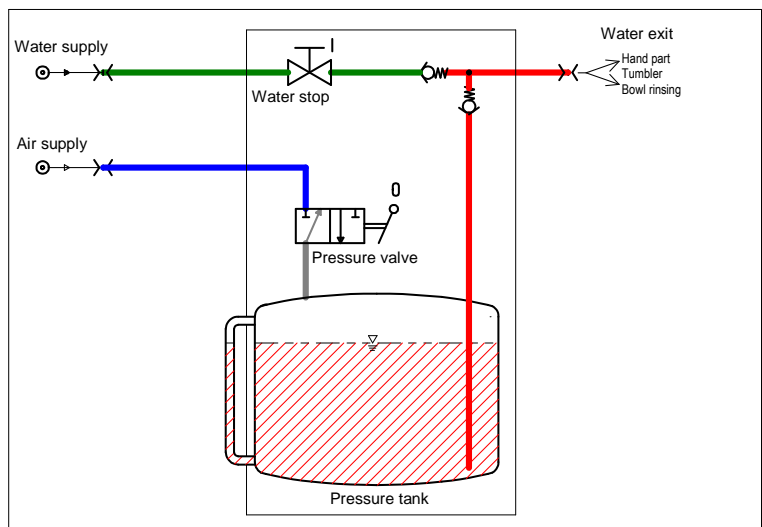

4 Rinsing/ Non-operation (on Mondays) (same picture as no. 1)

3 Operation

3.1 Switching the Weekend-System on and off

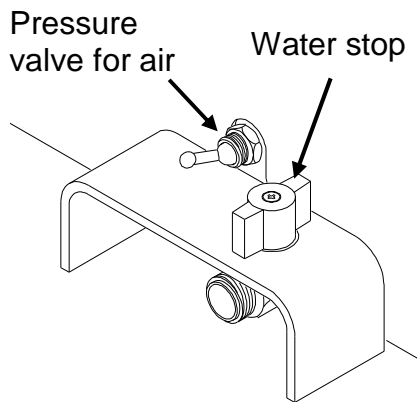

The operating agents are on the side of the device, above the cover for the supplies.

You can switch the compressed air for the tank on and off using the toggle switch of the pressure valve. The compressed air must only be switched on when BILPRON shall be injected into the treatment unit.

During the injection of BILPRON the water has to be stopped with the turning knob of the water stop.

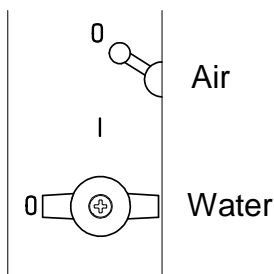

These operating instructions show the supplies in the top view so that the positions of both switches can be made out in a better way.

The required positions for switching on and off are identified by the marks „I“ and „0“ on the cover. In the non-operation of the Weekend-System all switches have to be at “0” as shown on the left.



Information

The toggle switch for the compressed air has always to be set on „0“ after having finished the injection of BILPRON!
The water stop should always be closed in the evening!

3.2 Filling the tank

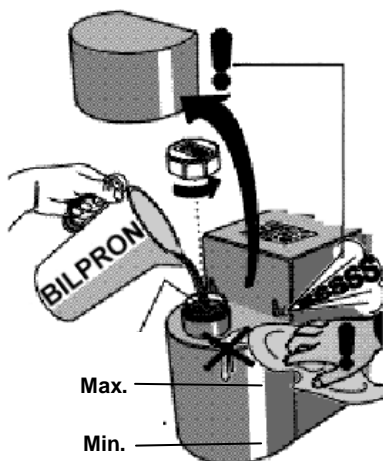

When the liquid level in the tank has dropped to „Min.“, the tank has to be refilled again! The level indicator is at the side of the casing.

Only fill the tank so that the liquid covers the mark “Max.”!

When refilling the tank, the toggle switch of the pressure valve has to be on “0”. While opening the tank, you hear a sibillance. This is normal as the compressed air escapes from the tank.

Remove spilt BILPRON immediately with a damp cloth.



Attention!

Only fill the tank so that the liquid does not cover more than up to the bottom of the filter.

If the fill level is too high, liquid might enter the Weekend-System via the air-relief valve!



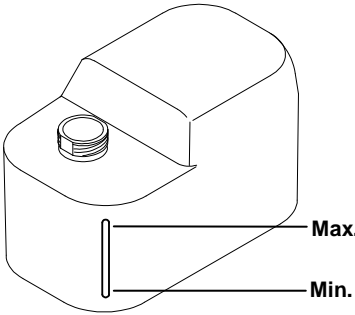
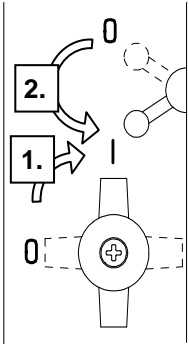
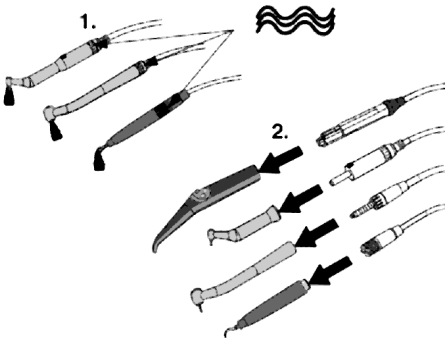
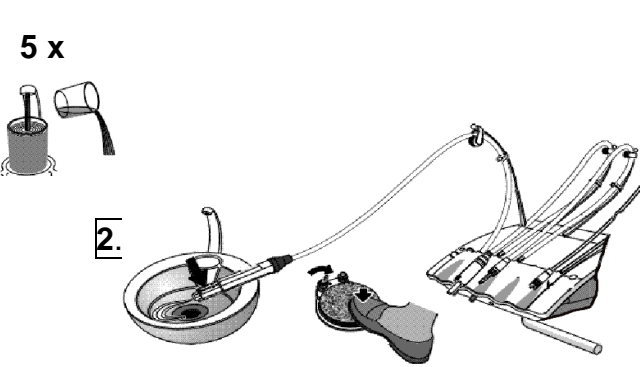

3.3 Chronological procedure of application

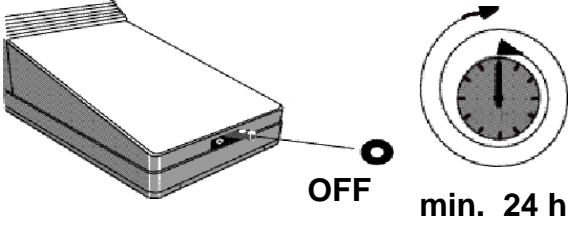
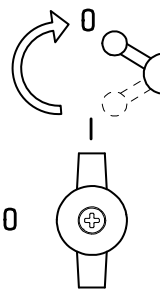
“On Fridays” (or before downtimes of several days’ duration): **Inject BILPRON**

	Procedure	Remarks
a)	<p>Check if enough BILPRON is in the tank:</p> <p>The level indicator at the side has to show a liquid level at „Max.“.</p> 	<p>Filling of the tank: see Chapter 3.2</p>
b)	<p>Switch on the Weekend-System:</p> <p>1. First turn off the water: <u>Set the water stop (ball valve) on “I”.</u></p> <p>2. Then pressurize the tank: <u>Set the toggle switch of the pressure valve on “I”.</u></p> 	<p>The operating agents are on the side cover.</p> <div style="border: 1px solid black; padding: 10px; text-align: center;"> <p>Decontamination: Set all levers on I</p> </div>
c)	<p>Adjust all instruments to maximum flow and remove them:</p> 	
d)	<p>Rinse <u>each</u> line until the blue decontamination agent “BILPRON” comes out:</p> <p>1. 5 x</p> 	<ol style="list-style-type: none"> 1. You should start with the tumbler filler in order to flood the main lines as soon as possible. Operate the tumbler several times. 2. Then continue with the multifunctional syringes and finally rinse the lines with the smallest flow. 3. All instruments which are additionally connected to the dental unit (scaler, powder jet devices etc.) have also to be rinsed. 4. If the tank is empty, BILPRON has to be refilled as described in Chapter 3.2.

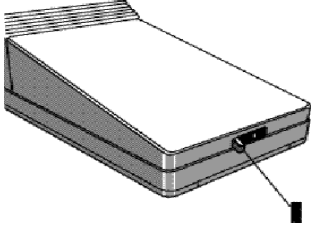
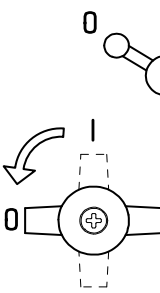
e)	<p>Switch off the treatment unit (if necessary at the main switch)!</p> 		
f)	<p>Depressurize the tank: <u>Set the toggle switch of the pressure valve on "0"</u></p> <p>Keep the water stop closed!</p>		<p>The operating agents are on the side cover.</p>

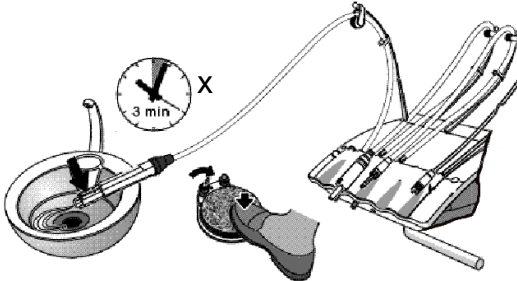
“On Mondays” (or after downtimes of several days’ duration): **Rinse out BILPRON**

	Procedure	Remarks	
g)	<p>Switch on the treatment unit:</p> 		
h)	<p>Turn the water on again: <u>Set the water stop (ball valve) on</u></p>		<p>The operating agents are on the side cover.</p> <div style="border: 1px solid black; padding: 10px; text-align: center;"> <p>Normal operation: Set all levers on 0</p> </div>
i)	<p>Rinse <u>each</u> line until clear water comes out:</p> <p>1.</p>  <p>10 x</p> <p>2.</p>  <p>3 min X</p>	<p>Start with the tumbler filler and the multifunctional syringes in order to rinse the main lines as soon as possible.</p> <p>Rinse all instruments one after another for approx. 3 minutes.</p>	
j)		<p>Record the decontamination with BILPRON in the device record book.</p>	

4 Maintenance

Filter



Information

The water filter should be examined by a dental engineer at least once a year and changed if necessary.

Tank cap

The threads of the tank cap and tank neck should be cleaned from time to time and should be slightly greased with vaseline.

Cleaning

Please use a clean cloth and cleaning agents which are free of aldehydes and alcohol. We recommend PlastiSept or DesNet.

5 Troubleshooting

Before contacting your technical engineer, first please refer to this list of faults. Many problems can be solved easily and without calling in an engineer.

Problem

Possible cause and solution

Liquid overflows out of the Weekend-System

Possibly the tank has been overfilled

No water flows

Perhaps the water stop is still closed. Open the valve (see Chapter 3.1)

Too little water flows

The filters in the treatment unit and in the Weekend-System might have to be cleaned by a dental engineer.

It is difficult to open the tank

Slightly grease the thread in the tank cap with vaseline and do not overtighten the cap. However, the black sealing ring must be covered at least two thirds.

II. Installation instructions

(for qualified technical staff only)

The procedures described below must only be carried out by suitably qualified technicians for dental devices in accordance with the valid instructions for electrical safety and the drinking water decree.

Directive 93/42/EEC for medical devices, annex I; paragraph 9.1

If a product is meant for use in combination with other products or equipments, the combination including the connections must be safe and it must not affect the intended function of the products. Each restriction of use must be stated on the label or in the operating instructions.

1 Initial thorough cleaning of the water lines



Attention!

The initial thorough cleaning of the water lines with the Biofilm-Removing-Set must **not** be carried out through the Weekend-System!

BIOFILM-REMOVING-SET

Application of the BIOFILM-REMOVING-SET

The Biofilm-Removing-Set serves for the removal of biofilm in the water lines of the treatment unit.

An application is required for treatment units which have been in use for more than one year when the Weekend-System is installed and must be carried out by a technician.

The Biofilm-Removing-Set contains step-by-step instructions which explain its use in detail.



Information

All hand and angle parts, instruments for the removal of dental tartar, multifunctional syringes and so on must be removed completely so that the water lines within these instruments are not blocked due to the cleaning process.



Attention!

The initial thorough cleaning of the water lines with the Biofilm-Removing-Set must not be carried out through the Weekend-System!

5 ltr. pressure tank system with connection for tube 6/4 ALPRO article no. 8589

For the initial cleaning of the water lines an external pressure tank system must always be used by means of which the BRS liquids can be injected into the water lines of the treatment unit with at least 2 bar.

A garden spray device with pump mechanism and pressure storage function in which a tube connection instead of a syringe can be screwed would be very suitable.

2 Position and connection of the Weekend-System

2.1 Delivery contents

- Weekend-System
- Lead wires
- Operating instructions
- Device records

2.2 Position with respect to the treatment unit

The position of the device with respect to the treatment unit should be chosen with care so that it cannot cause an obstruction to movement within the surgery but after installation the Weekend-System must be accessible as it is important that the tank can be filled easily.

2.3 Connection to the treatment unit



The Weekend-System must only be connected by an expert authorized by ALPRO in accordance with the valid instructions for the drinking water decree. Caution: Unauthorised interference to the treatment unit can invalidate the manufacturers guarantee. Please check the conditions of the guarantee.

For the connection of the air and water pipes please use the the pipes, T-pieces and couplings included in the delivery contents.

a) Water supply

As a rule the supply is connected with a flexible metal tube (armoured tube included in delivery) directly at the angle valve in the connection box of the treatment unit. It can also be connected behind the valve so that the Weekend-System becomes depressurised when switching off the treatment unit!



If the water pressure in the incoming pipe is higher than 6 bar, an appropriate pressure control has to be assembled in front of the Weekend-System!

b) Water exit

The outgoing pipe of the Weekend-System has to be connected with the pipe of the treatment unit to the instruments, to the tumbler filler and to the bowl rinsing. If possible, this should be done with a flexible metal tube

(included in delivery) which has to be connected to the central water supply of the treatment unit.

If necessary, the pipes of the treatment unit to the instruments, to the tumbler filler and to the bowl rinsing are to change so that they are connected together to one pipe.

c) Compressed air entrance

The compressed air pipe (blue) of the Weekend-System should be connected into the treatment unit. To do so, the compressed air pipe in the treatment unit must be separated behind the pressure control and a T-piece must be installed. The pressure in this pipe must be at least 2 bar.



2.4 Connection diagram

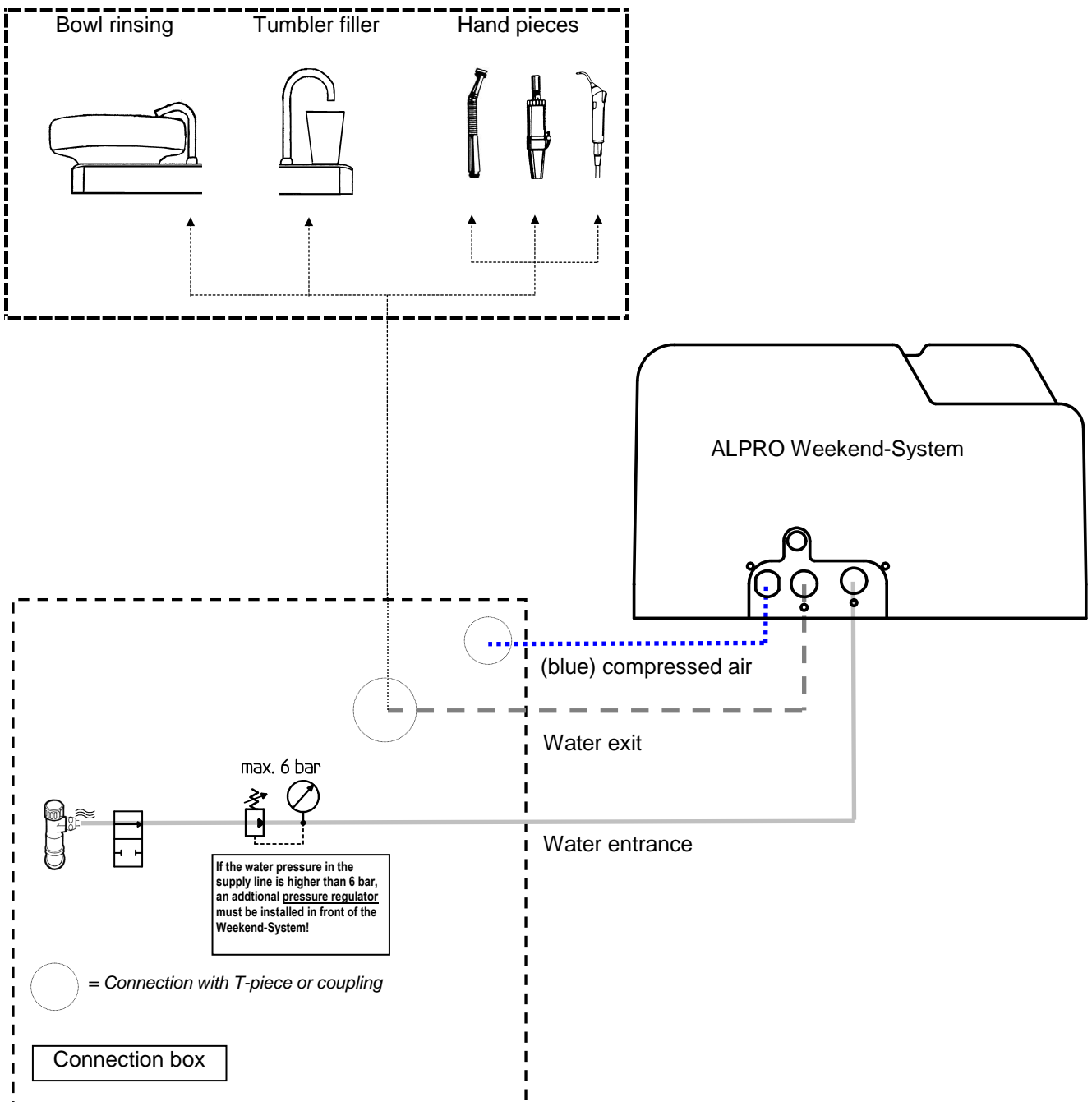

2.5 Instructions for installation

- a) Switch off power supply of the treatment unit using the main switch!
- b) Close angle valve in the connection box and relieve the water pipe system of the treatment unit of pressure, e.g. by operating the multifunctional syringe.
- c) Fix a position for the Weekend-System (see paragraph 2.2)
- d) Seek a suitable entrance into connection box of the treatment unit or prepare it yourself (diameter approx. 30 mm).
- e) Connect the connecting lines of the Weekend-System to the treatment unit as described in Chapter 2.3 and 2.4.

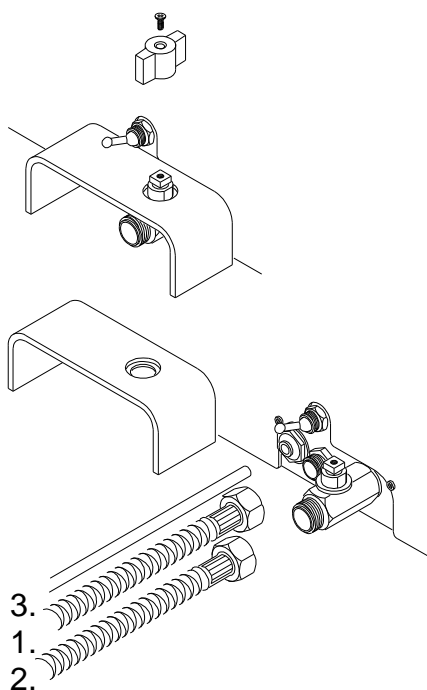

- f) Unscrew the screw in the turning knob of the water stop and remove the turning knob.
Remember the position of the turning knob!

Remove the cover.

- g) Fit the pipes for water and compressed air at the Weekend-System:
 1. First screw the outgoing pipe on the middle supply.
 2. Afterwards fit the incoming pipe to the water stop.
 3. Last insert the plastic tube into the quick coupling.



When installing the device in the practice, secure with a flat wrench (SW 21) when screwing the water tubes to the device in order to prevent the connections in the casing from being damaged.

- h) Fit the cover and the turning knob again. Put the turning knob into the same position as it was before the dismantling (f)!
- i) Open the angle in the connection box again and switch on the main switch of the treatment unit.

3 Specifications

3.1 Technical values

Operating data

Filling amount: Min.: 200 ml, Max.: 900 ml
Microfilter: 80 µm (Filter F2)

Connection data

Media: Compressed air: without oil, drained and filtered
Water : filtered (80 µm)

Maximum admissible pressures: Air pressure in incoming pipes: 8 bar
Air pressure in the tank: 2 bar
Pressure of incoming water: 6 bar

Connection lines: Incoming air pipe: blue PE-/PA-tube 6/4x1
Water pipes: metalized tubes

Measures and weight

Measurements (without tubes): width x length x height: 20 cm x 29 cm x 18,5 cm

Weight (empty): approx. 2,5 kg

Material: Chassis: sheet steel, galvanized
Casing: plastics (ABS)
Tank: plastics (HDPE)
Screwed connections: plastics (POM), brass
Tubes: polyamide polyethylene, high-grade steel

3.2 Diagram of the device (without casing)

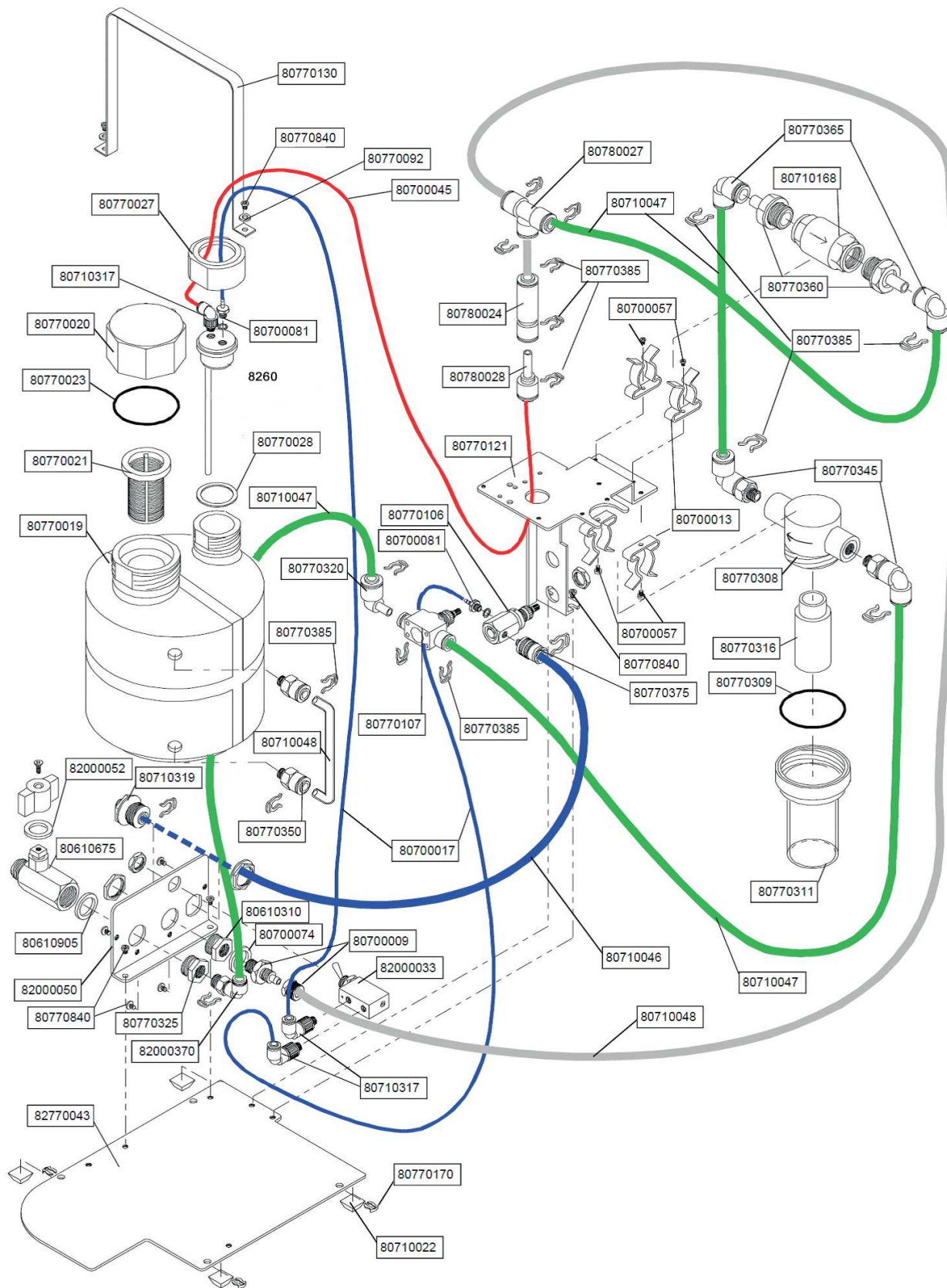

3.3 Spare parts

Article	Art. no.
Tank cap	80770020
Seal for tank cap	80770023
Filter for tank	80770021
Filter insert 80µ	80770316
Installation kit	8220

3.4 Circuit diagram

